



A Kingspan Group Company

VM Zinc Available

Exposed Fastener Series

- Equal to current 7/8" Corrugated Panel offer

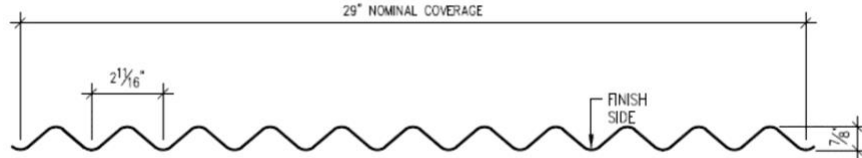

C-29 Panel

Matrix Series

- Vertical Wall Applications ONLY. (due to minimum slope recommendations)

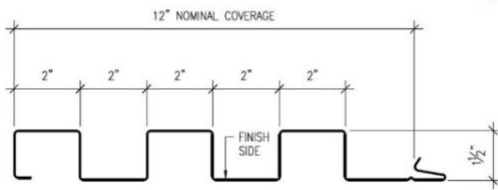

MX 1.0

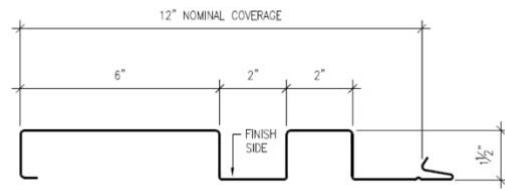

MX 2.0

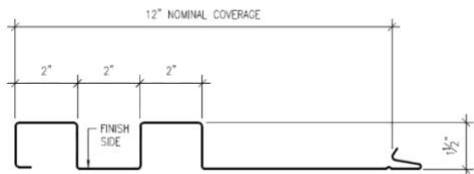

MX 3.0

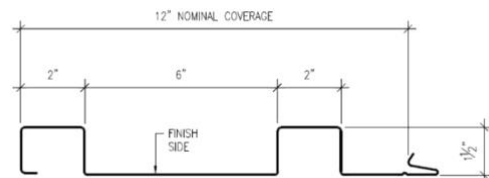

MX 4.0

VM Zinc Available

Integrity Series

- Vertical and Horizontal Wall Applications
- Hidden Fastener

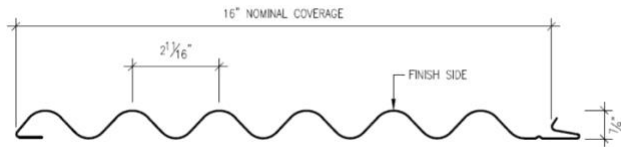

S-16

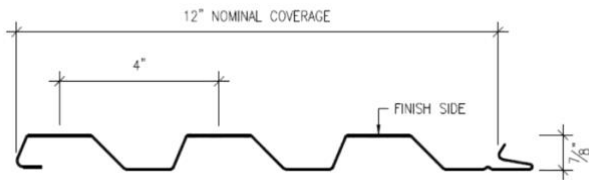

X-12

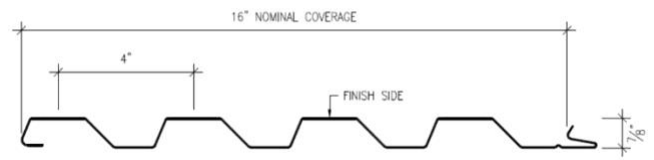

X-16

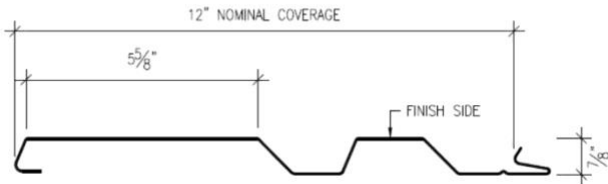

XA-12

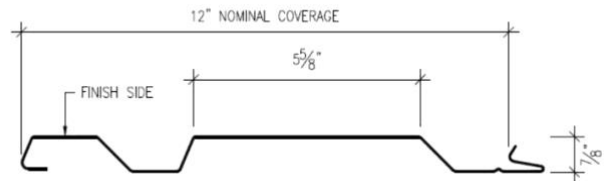

XB-12

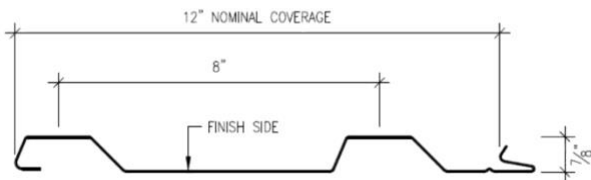

XE-12

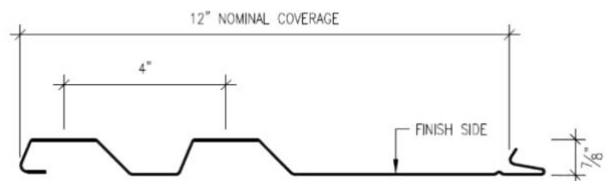

XF-12

VM ZINC AVAILABLE

Concealed Series

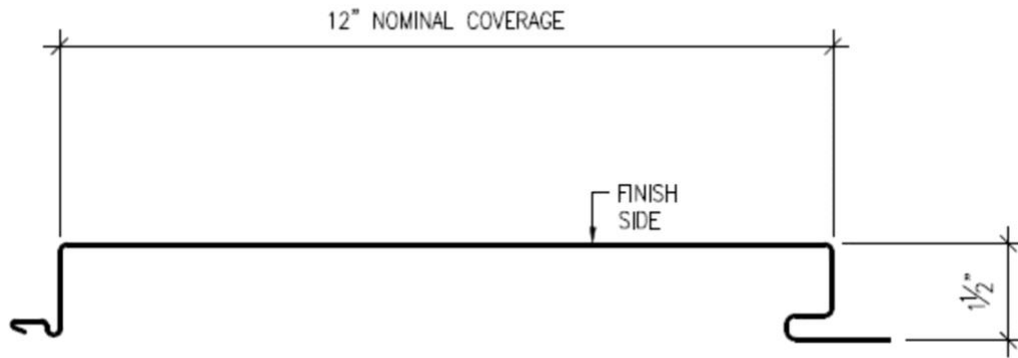

Morin®

F-12

- Similar to current Interlocking Panel offer

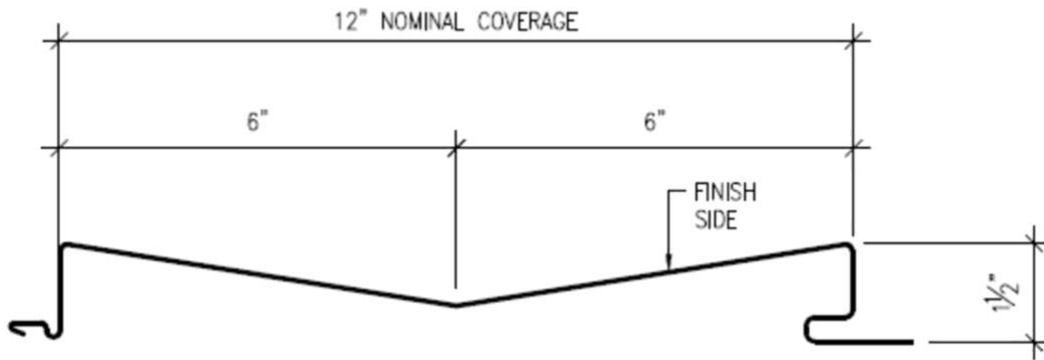

Morin®

W-12

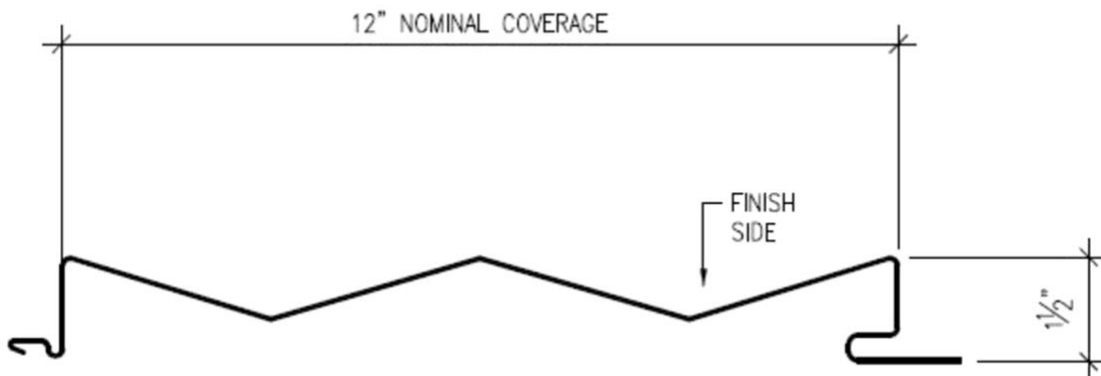

Z-12